



Design and Simulation of Boost Converter with MPPT Techniques

Chitra Laksmanasamy

Assistant Professor (SS), Department of Electrical and Electronics Engineering,
Dr. Mahalingam College of Engineering and Technology, Pollachi, India
Email: chitral@drmcet.ac.in

Porkodi Rathinasamy

PG Scholar, Department of Electrical and Electronics Engineering,
Dr. Mahalingam College of Engineering and Technology, Pollachi, India
Department of Author, Affiliation, Country
Email: porkodi508@gamil.com

Abstract: *The increase in use of renewable energy sources lead to use more of photovoltaic system which has higher advantages than others. The power from solar panel is difficult to track because sudden change in solar irradiation and other climatic conditions. Therefore power is extracted with the help of MPPT algorithm. In this paper, solar panel is designed for 18V input and 147V output conditions. The controller is designed with P&O and Incremental conductance algorithm and their results are compared. From the simulation results it is observed that incremental conductance algorithm has better performance.*

Keyword: *Photovoltaic Panel (PV); Maximum Power Point Tracker (MPPT); Perturb and Observation (P&O)*

1. INTRODUCTION

Energy demand is increased due to dense population, but the fossil fuels coal, uranium, oil, gas and etc. are limited, so we need the alternative energy sources. Renewable energy sources play vital role in electricity generation. Different renewable energy sources like wind, solar PV, biomass and fuel cells can be used for the alternate option of the generation of electricity and completes our daily energy demand. Renewable energy sources acquiring importance due to its enormous consumption and exhaustion of fossil fuel. Energy from the sun is one of the best option for electricity generation as it is free pollution and freely available everywhere. The solar photovoltaic power will play a vital role in alleviating the energy crisis and reducing the environment pollution [1] [2].

The solar photovoltaic array can directly converted the solar energy into electrical energy, but efficiency of the PV system is low and cost is high. The photovoltaic (PV) power generation systems are popularly used in commercial and residential areas [3] [4]. For low input voltage from PV panel cannot make higher efficiency at PV inverter [5]. Several converter topologies are proposed to increase PV output voltage as we required. [6-8].

The single phase buck converter reduces the output voltage which in turn decreases the efficiency of converter and buck-boost converter requires input filter as input current is pulsating due to switching of power switch, even though buck converter is able to step up

or step down input voltage it gives negative output voltage while boost converters gives high output voltage, low operating duty cycle and also lower voltage across switch [9] [10]. It also provide less input current ripple, which in turn decreases the conduction loss of the switch. The output efficiency of solar array depends on many factors such as irradiance, temperature, etc. During cloudy weather due to varying insolation levels the output of the array keeps varying. The efficiency of the photovoltaic system may be increased by using maximum power point tracker (MPPT). So, we need a tracker, which track maximum current and voltage at a point [11].

There are two different ways to extract maximum output from PV panel one is mechanical tracking another one is electrical tracking. The Mechanical tracking is obtained the direction of PV panel oriented in such a way that to get maximum power from the sun. The electrical tracking is obtained by manipulating the load to get maximum output under changing condition of irradiation and temperature. The selection of the algorithm depends on the time duration, cheaper and simpler. There are many different MPPT techniques which depend on its different topologies and varying complexity, cost and production efficiency, are perturb and observation, incremental conductance, constant reference voltage or current, these techniques are used for increase the efficiency of PV system [12] [13].

Among them P&O and Incremental conductance

algorithm can track maximum power point, easy to implement and cost effective method. Among these two techniques incremental conductance algorithm gives good dynamic response and also it incorporates sudden change in temperature and irradiation. Hence Incremental conductance MPPT algorithm is suggested. In this paper, presents a comparative study of two MPPT algorithm techniques under different solar irradiances in order to optimize the efficiency of the solar PV system. Perturb and Observation and Incremental conductance techniques applied to a dc-dc Boost converter device [14-16]. The proposed techniques are well adjusting the duty cycle of the boost converter switch to track the maximum power and increase efficiency of a solar PV array [17] [18]. The proposed controller method is simulated by using Matlab/Simulink. The Simulation and analysis of incremental conductance and perturb and observation are presented.

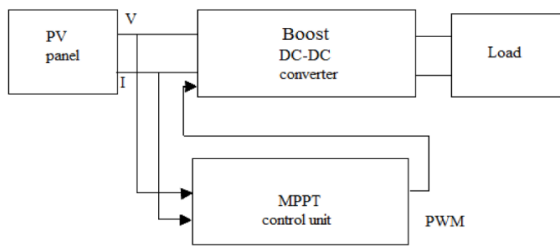

Figure 1 Blockdiagram

2. MATHEMATICAL MODEL OF PHOTOVOLTAIC PANEL

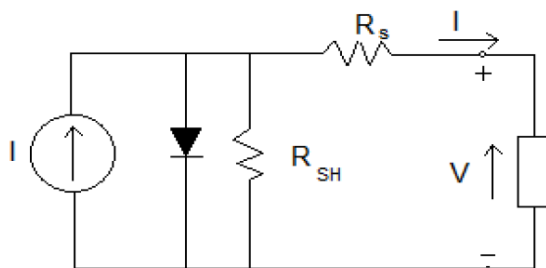

Figure 2 Single diode equivalent circuit

The PV array is build-up of solar cell, which is basically a p-n semiconductor junction, shown in Fig.2. The characteristic of a solar array is given by Eq. (1). the main equation of output module [19].

$$I_o = Np * I_{ph} - Np * I_{rs} \left[\exp\left(\frac{Kov}{N_s}\right) - 1 \right] \quad (1)$$

Where:

- V is voltage across solar panel terminal.
- I is current across solar panel terminal.
- I_{ph} is the photon current.
- I_{rs} is the reverse saturation current.
- I_o is the solar output current.

- k is the Boltzmann constant.
- N_p is number of solar cells connected in parallel.
- N_s is number of solar cells connected in series.

3. MPPT TECHNIQUES

3.1 Perturb and Observation MPPT Algorithm

The P&O techniques periodically perturbs (i.e. increments or decrements) the array terminal output voltage and compares the PV output power with that of the previous perturbation cycle[20] [21]. If the PV array operating voltage varies and power increases, the control system moves the PV array operating point in that direction; otherwise the operating point is moved in the opposite direction. In the next perturbation cycle the algorithm continues in the same manner.

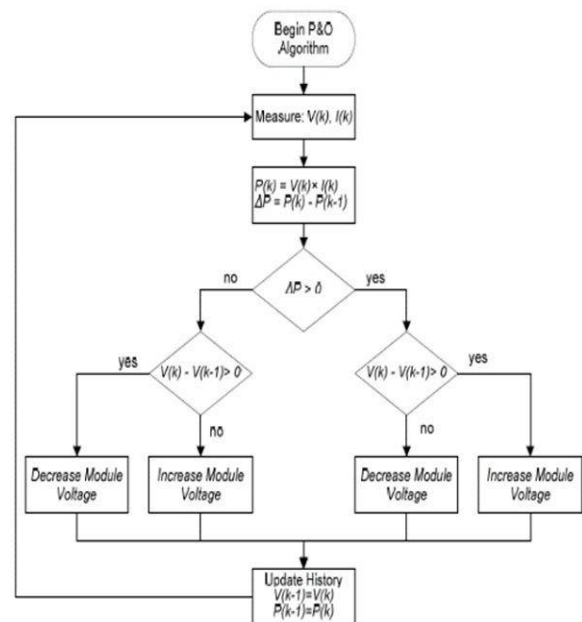

Figure 3 P&O Algorithm

3.2 Proposed Incremental Conductance MPPT Algorithm

Maximum power point tracking is the automatic adjustment of the load of a photovoltaic system to achieve the maximum power output. PV cells have a complex relationship between voltage, current and output power, which produces a non-linear output. This output is demonstrated as the current-voltage characteristic of the PV cell. In this method PV array's incremental conductance (di/dv) to compute the sign of dP/dV. When di/dV is equal and opposite to the value of I/V the algorithm knows the maximum power point is reached and it terminates. This method tracks

rapidly changing irradiation conditions more accurately than P&O method [22] [23].

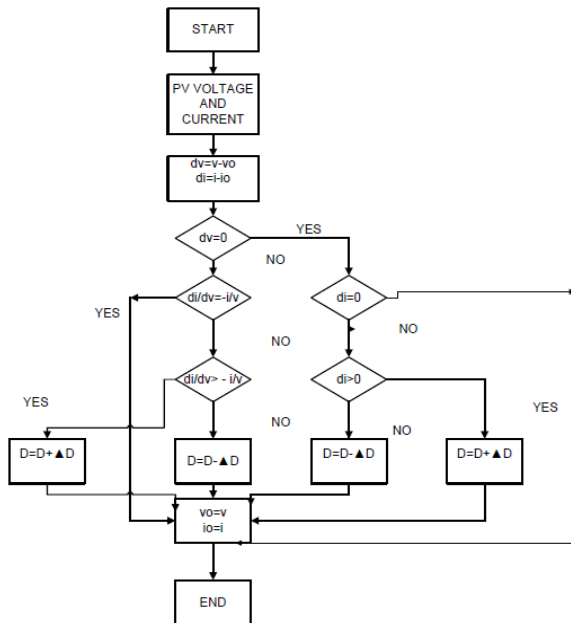

Figure 4 Incremental Conductance Algorithm

4. BOOST CONVERTER WITH MPPT ALGORITHM

The single-input boost converter with P&O algorithm is shown in figure.

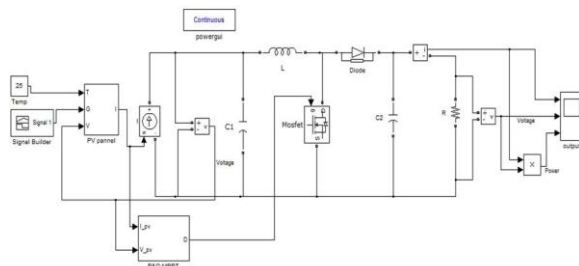

Figure 5 Boost converter with P&O Algorithm

The boost converter with Incremental Conductance algorithm is shown in figure.

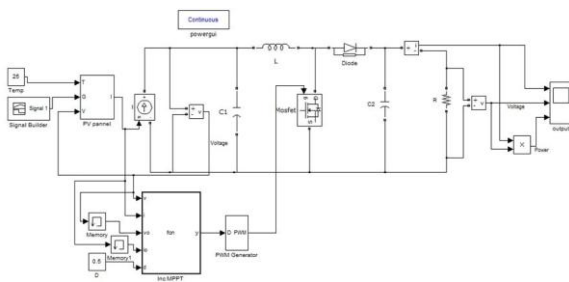

Figure 6 Boost Converter with Incremental Conductance Algorithm

5. SIMULATION RESULTS

The solar panel DS-100M is simulated with following specifications.

TABLE I SPECIFICATIONS OF DS-100M PANEL

NAME	DS-100M
Rated power (Vmp)	100 W
Voltage at maximum power (Vmp)	18V
Current at maximum power (Imp)	5.55 A
Open circuit voltage (VOC)	21.6 V
Short circuit current (ISC)	6.11 A
Total number of cells in series (NS)	36
Total number of cells in parallel (NP)	1
Maximum system voltage	1000 V
Range of operation temperature	-40 °C to 80 °C

The P-V and I-V curve for different solar irradiance is simulated.

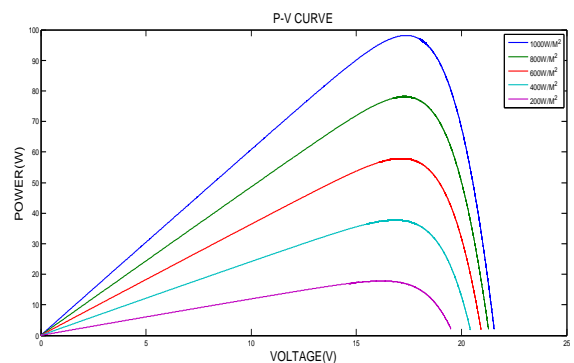

Figure 7 P-V Curve under Different Solar Irradiance

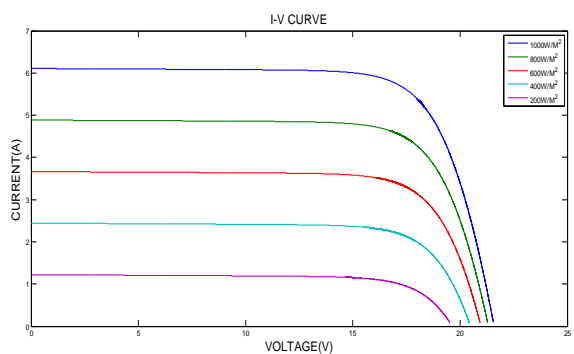

Figure 8 I-V Curve under Different Solar Irradiance

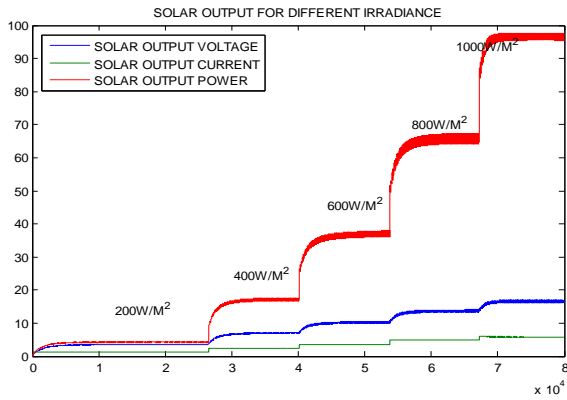

Figure 9 Solar output voltage, current and power under Different Solar Irradiance

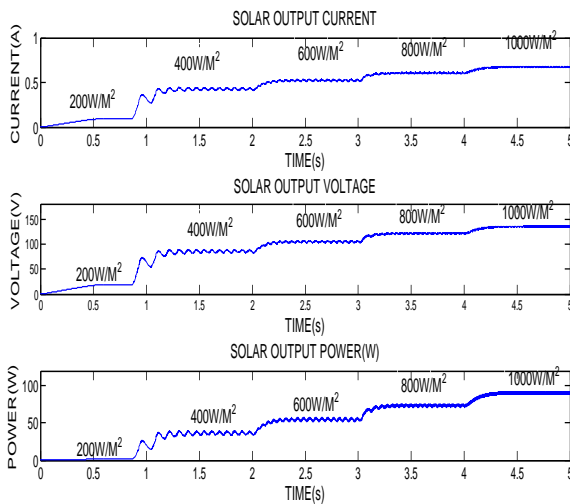

Figure 10 P&O output current, voltage and power under Different Solar Irradiance

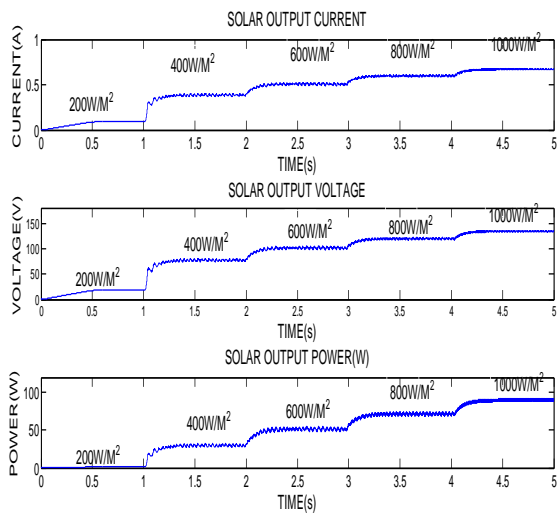

Figure 11 Incremental output current, voltage and power under Different Solar Irradiance

6. COMPARISON BETWEEN P&O AND INCREMENTAL CONDUCTANCE

The comparison of current, voltage and power between P&O and Incremental Conductance algorithm are made.

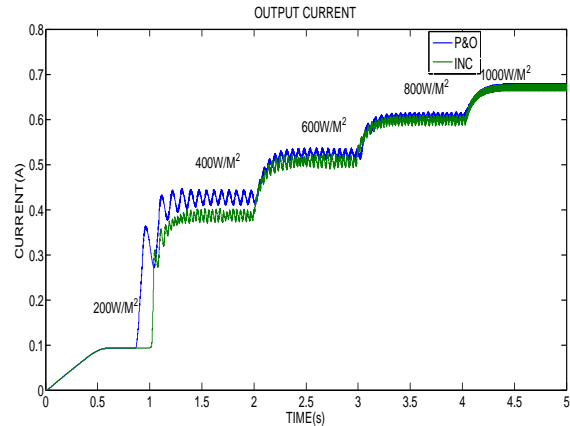

Figure 12 P&O and IC Current Comparison

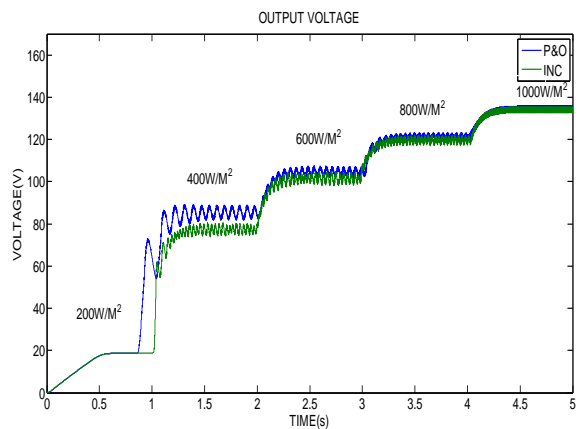

Figure 13 P&O and IC Voltage Comparison

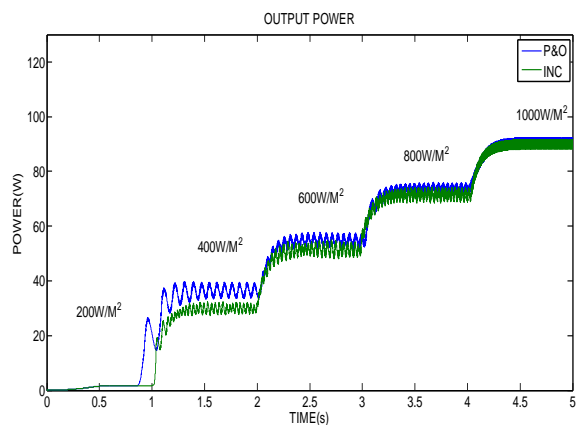

Figure 14 P&O and IC Power Comparison

The output current, voltage, power of P&O and Incremental algorithm is compared with each other parameters result with nearby output power but the incremental conductance algorithm tracks MPP at 0.083s has better performance than P&O algorithm. Boost converter with incremental gives better output power for rapidly changing atmospheric conditions.

7. CONCLUSION

The principle of operation and analysis of different converters with DC-DC converter, the maximum power point tracking is successfully carried out by this research using perturb and observation and incremental conductance algorithm are presented in this paper. The PV module working on photovoltaic effect actually improves the system efficiency. Compared to perturb and observation method of maximum power point tracking, incremental conductance algorithm tracks seems to be easy for the optimization of the photovoltaic system using boost converter and gives smooth increment in power under varying atmospheric radiations. By varying the duty cycle of the boost converter, the source impedance can be matched to adjust the load impedance which increases the efficiency of the system. The Performance has been studied using MATLAB/Simulink.

REFERENCES

- [1] S.Mekhilef, R. Saidur and A.Safari (2011), "A Review of Solar Energy use in Industries", *Elsevier Renewable and Sustainable Energy Reviews*, Vol.15, pp. 1777-1790.
- [2] K.H. Solangi, M.R. Islam, R.Saidur, N.A. Rahim and H.Fayaz (2011), "A Review on global Solar Energy Policy", *Elsevier Renewable and Sustainable Energy Reviews*, Vol.15, pp. 2149-216.
- [3] R.-J. Wai, W.-H. Wang, and C.-Y. Lin (2008), "High-performance stand-alone photovoltaic generation system," *IEEE Trans. Ind. Electron.*, vol. 55, no. 1, pp.240–250.
- [4] C.Wang and M. H. Nehrir(2008), "Power management of a standalone wind/photovoltaic/fuel cell energy system," *IEEE Trans. Energy Convers.*, vol. 23, no. 3, pp. 957–967.
- [5] J. Ramprabu, K. Deepa (2016) , "Performance Analysis of a Seamless Sliding Mode Control for a Non Isolated Multi-Input Multi-Output Bidirectional Dc-Dc Boost Converter for Electric Vehicle Applications", *International Journal of Advances in Computer and Electronics Engineering*, Volume 1, Issue 3, pp. 1-9.
- [6] J. Ramprabu, J.M. Subashini (2016), "Design and Stability Analysis of Four-in-Wheel Drive Electric Vehicle Based on Variable Structure Control Algorithm ", *International Journal of Advances in Computer and Electronics Engineering*, Volume 1, Issue 3, pp. 10-16.
- [7] S. B. Kjaer, J. K. Pedersen, and F. Blaabjerg (2005), "A review of single-phase grid-connected inverters for photovoltaic modules," *IEEE Trans. Ind. Appl.*, vol. 41, no. 5, pp. 1292–1306.
- [8] B. S. Thansoe, N. A. R. G. K. A.S., and L. C. J.(2006), "The Study and Evaluation of Maximum Power Point Tracking Systems," *International Conference on Energy and Environment (ICEE 2006)*, pp.17-22.
- [9] R.Mahalakshmi, Aswin Kumar.A., Aravind Kumar (2014), "Design of Fuzzy Logic Based Maximum Power Point Tracking Controller for Solar Array for Cloudy Weather Conditions," *IEEE Power and Energy System: Towards Sustainable Energy*, Volume 1, p.p.1-4.
- [10] H. Patel and V. Agarwal (2008), "MPPT scheme for PV systems operating under partially shaded conditions," *IEEE Transactions on Industrial Electronics*, vol.55, no. 4, pp. 1689–1698.
- [11] L. Chitra, M.Karpagam, K. Saranyadevi(2016), "Proposal of High Gain, Reduced Stress with Low Duty-Cycle Two-Input Boost Converter for Renewable Energy Systems" and Scientific Research Publishing
- [12] M. G. Villalva, J. R. Gazoli, E. Ruppert F (2009), "Comprehensive approach to modeling and simulation of photovoltaic arrays", *IEEE Transactions on Power Electronics*, vol. 25, no. 5, pp. 1198–1208.
- [13] Hairul Nissah Zainudin, Saad Mekhilef (2010), "Comparison Study of Maximum Power Point Tracker Techniques for PV Systems", Cairo University, Egypt, Paper ID 278.
- [14] Trishan Eram, Patrick L. Chapman (2007), "Comparison of Photovoltaic Array Maximum Power Point Tracking Techniques" *IEEE Transaction on Energy Conversion*, Vol.22, No. 2, p.p. 439-449.
- [15] Fangrui Liu, Shanxu Duan, Fei Liu, Bangyin Liu, and Yong Kang (2008), "A Variable Step Size INC MPPT Method for PV Systems" *IEEE Transactions On Industrial Electronics*, Vol.55, No.7, p.p.2622-2628.
- [16] Qiang Mei, Mingwei Shan, Liying Liu, and Josep M. Guerrero (2011), "A Novel Improved Variable Step-Size Incremental-Resistance MPPT Method for PV Systems" *IEEE Transactions On Industrial Electronics*, Vol.58, No.6, pp.2427-2434.
- [17] Mohammad Seifi, Azura Bt. Che Soh, Noor Izzrib. Abd. Wahab, and Mohd Khair B. Hassan (2013), "A Comparative Study of PV Models in Matlab/Simulink" *International Science Index Vol:7, No.2*, pp.102-107.
- [18] Youjie M., Deshu C., Xuesong Z., and Runrui G.(2011), "MPPT Control of Photovoltaic System based on Hybrid Modeling and its Simulation", *Proc. of International Conference on Sustainable Power Generation and Supply*, Nanjing, China, pp. 1-5.
- [19] Liand, W. and He, W. (2011) Review of Non-Isolated High Step-Up DC/DC Converters in Photovoltaic Grid-Connected Applications. *IEEE Transaction on Industrial Electronics*, pp.1239-1250.
- [20] E. I and O. Rivera (2008), "Maximum Power Point Tracking using the Optimal Duty Ratio for DC-DC Converters and Load Matching in Photovoltaic Applications," *IEEE Transaction on Industrial Electronics*, pp. 987-991.
- [21] Gow JA, Manning CD (1999), "Development of a photovoltaic array model for use in power-electronics simulation studies", *IEEE Proc Electr Power Appl*, Volume 2 , pp.146.
- [22] L. Piegari and R. Rizzo (2010), "Adaptive perturb and observe algorithm for photovoltaic maximum power point tracking," *IET Renewable Power Generation*, vol. 4, no. 4, pp. 317–328.
- [23] N. Femia, G. Petrone, G. Spagnuolo, and M. Vitelli (2005), "Optimization of perturb and observe maximum power point tracking method," *IEEE Trans. Power Electron.*, vol. 20, no. 4, pp. 963–973.
- [24] B. Liu, S. Duan, F. Liu, and P. Xu (2007), "Analysis and improvement of maximum power point tracking algorithm based on incremental conductance method for photovoltaic array," in *Proc. IEEE PEDS*, pp. 637–641.
- [25] S. Jain and V. Agarwal (2007), "New current control based MPPT technique for single stage grid connected PV systems,"

IEEE Trans. On Energy Conversion and Management, vol. 48, no. 2, pp. 625–644.

- [26] J. Applebaum (1987), “The Quality of Load Matching in a Direct coupling Photovoltaic System ”, *IEEE Trans. On Energy Conversion*, Vol. 2, No.4, pp.534-541.

Authors Biography



Chitra L., is a Assistant Professor (SS), of Department of EEE in Dr. Mahalingam college of Engineering & Technology. She completed her BE in EEE at Kumaraguru college of Technology. She completed her M.E in power electronics and drives at Karunya Deemed University. She is currently pursuing Ph.Dat

Anna University, Chennai. Her research interests are DC-DC converter, soft computing & Renewable Energy.



Porkodi. R., is a PG Student, in Dr. Mahalingam College of Engineering and Technology. She completed her BE in department of EEE at Dr. Mahalingam College of Engineering and Technology. She completed her M.E in department of Applied Electronics at Dr. Mahalingam College of

Engineering and Technology. Her research interests are power electronics, electrical machines.